

NAVOCEANO & JSH

Danielle Carpenter - NP321

Melissa Dykman – NP321

Bruce McKenzie – NP32T

What is JSH?

- Joint Polar Satellite System (JPSS) Stored Mission Data Hub
- First satellite – Suomi National Polar-orbiting Partnership (SNPP) – launched October 2011
 - JPSS-1 will launch in FY2017, JPSS-2 will launch FY2022
- NOAA also leverages mission partner assets for better global coverage, such as JAXA GCOM-W satellites

Current AMSR2 Data Usage

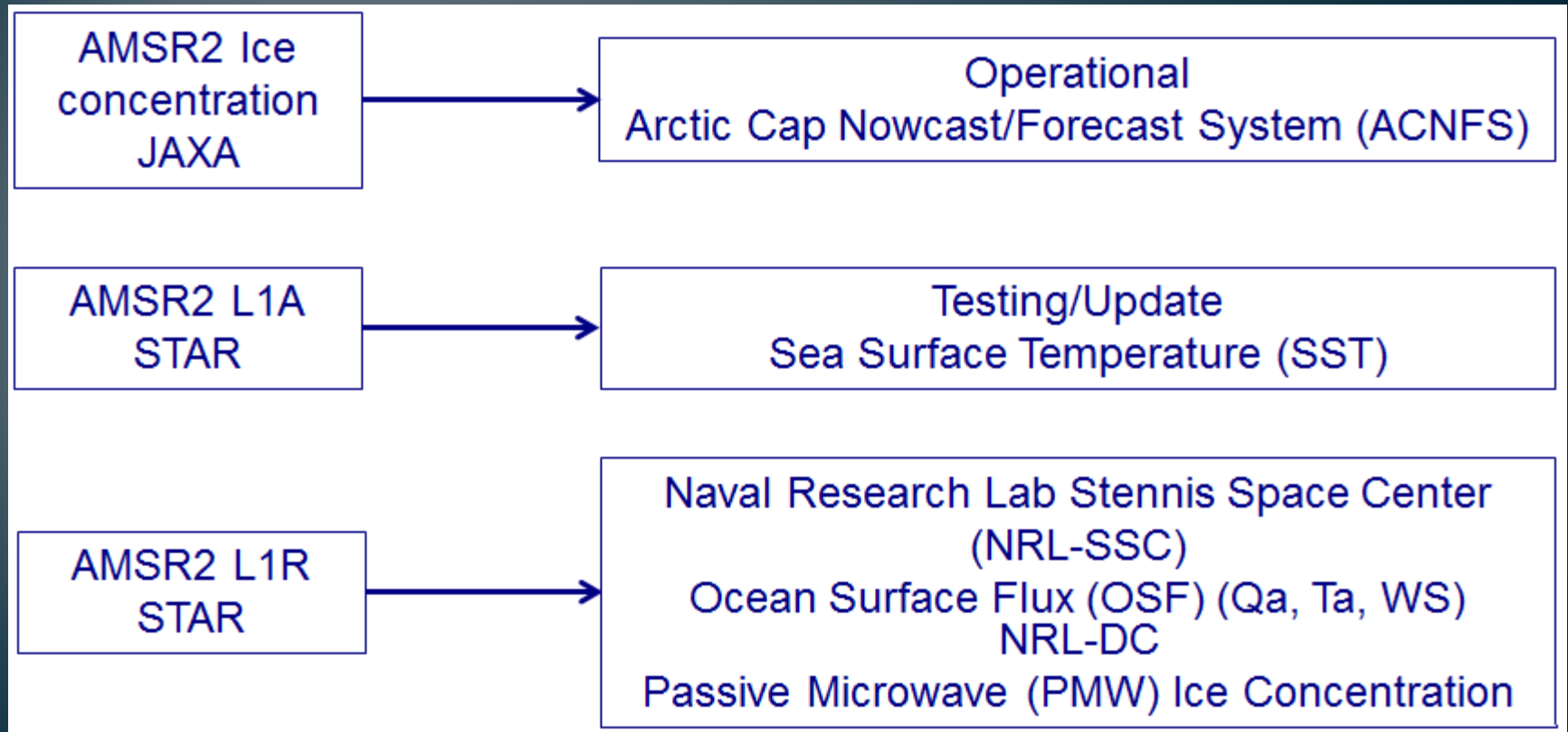

Current S-NPP Data Usage

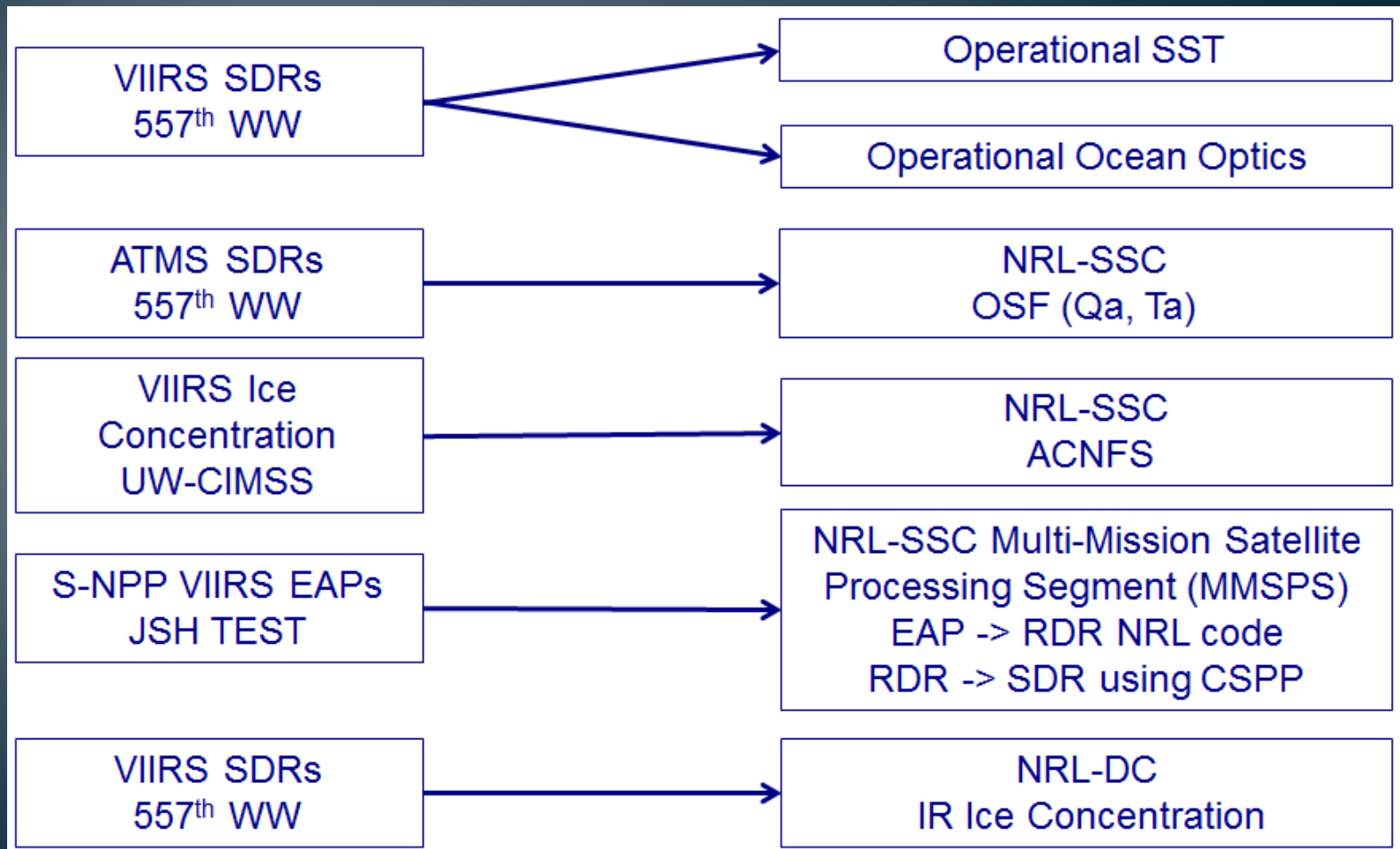

Future AMSR2 Data Usage

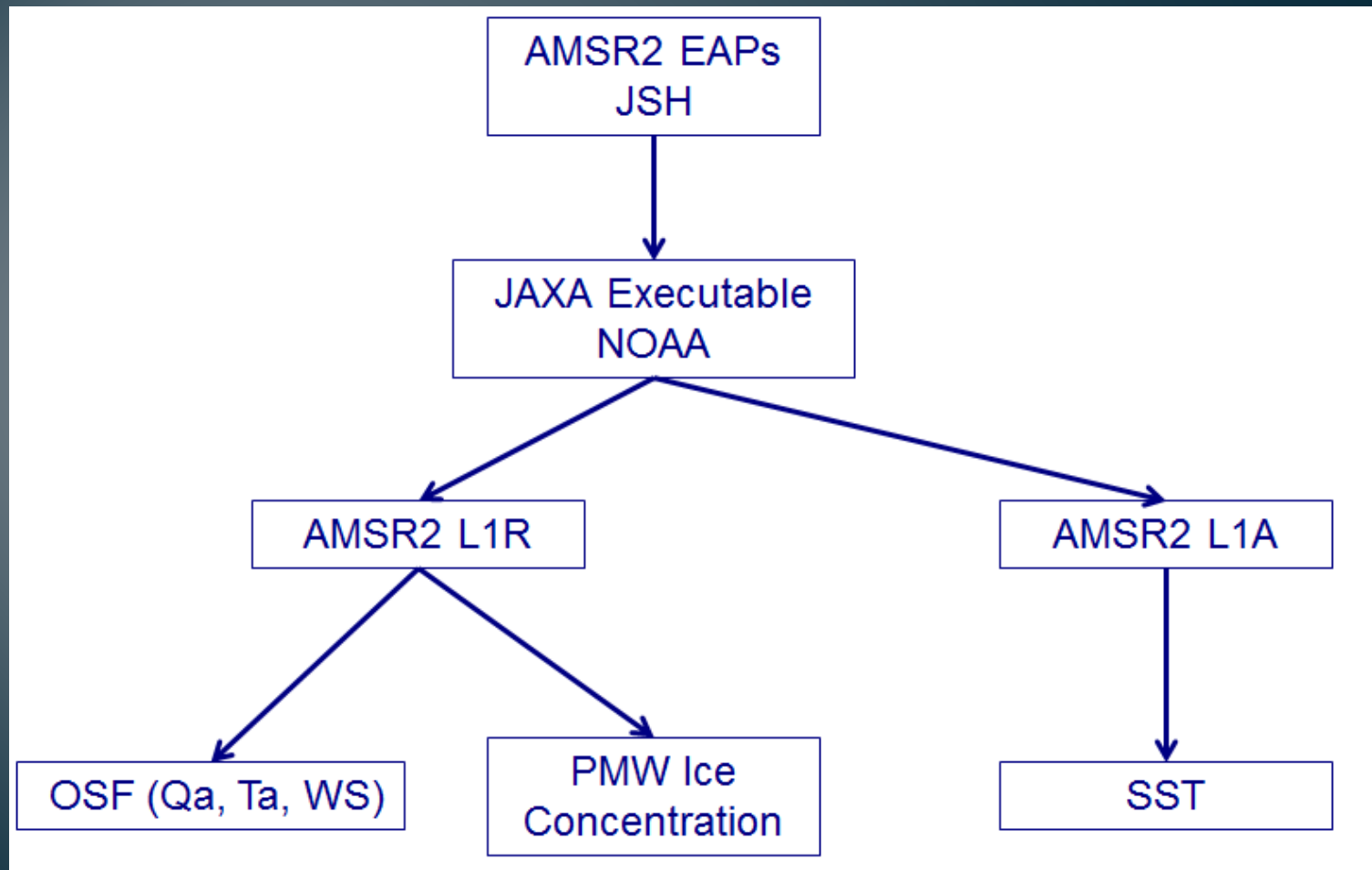

Future S-NPP/JPSS-1 Data Usage

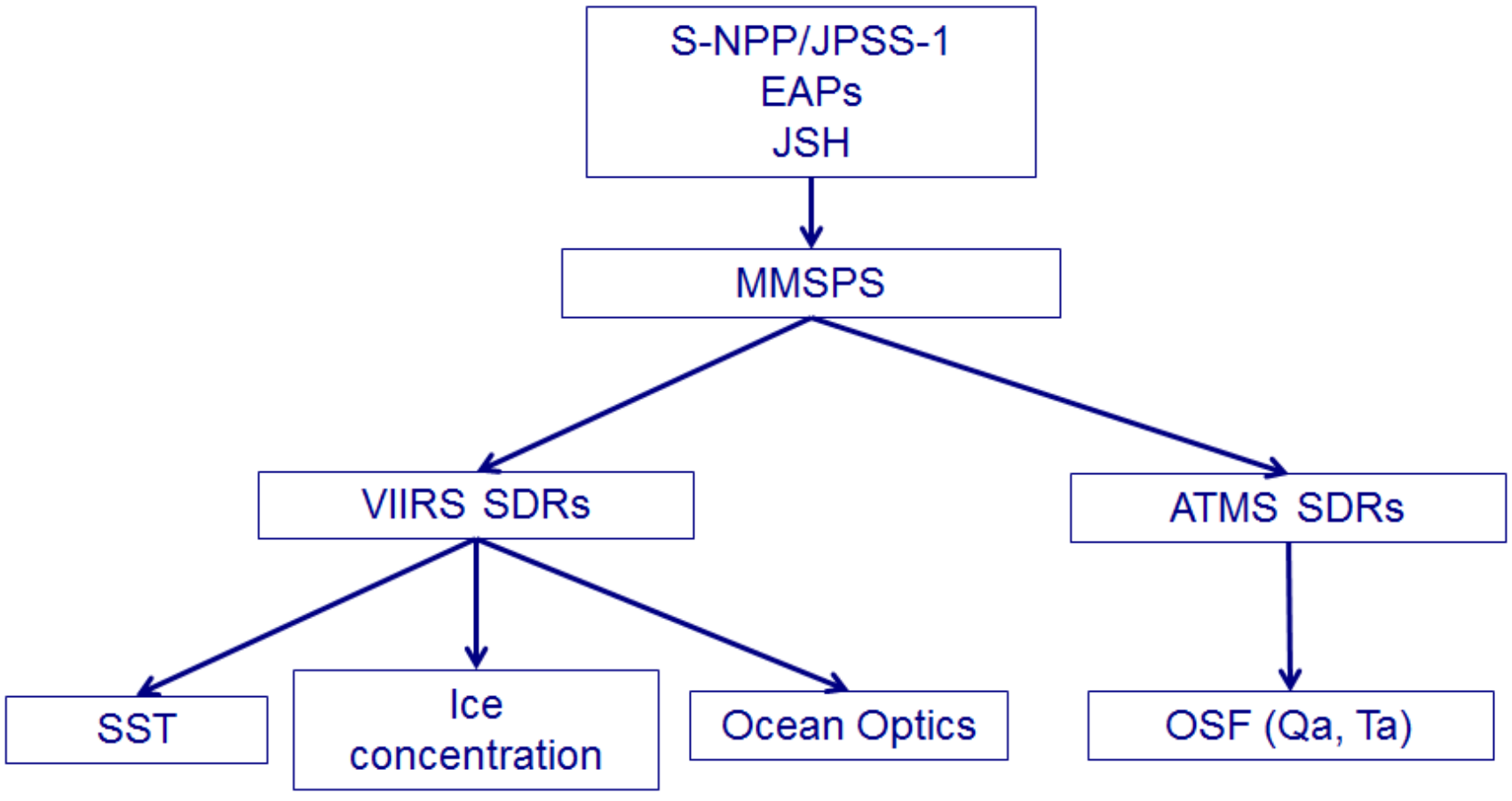

MMSPS System

System Processing Flow Overview

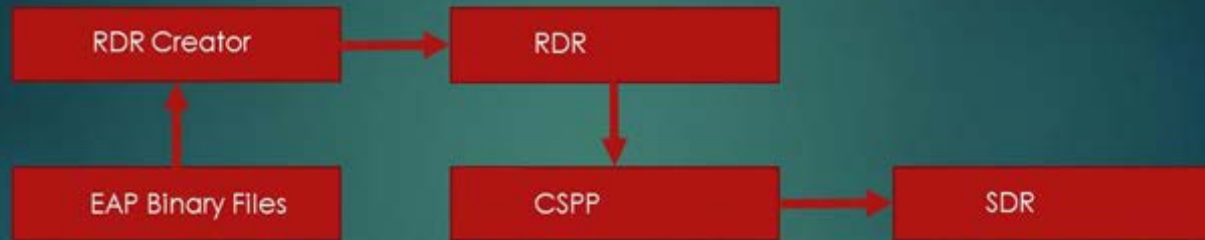

JPSS Block 2.0 System

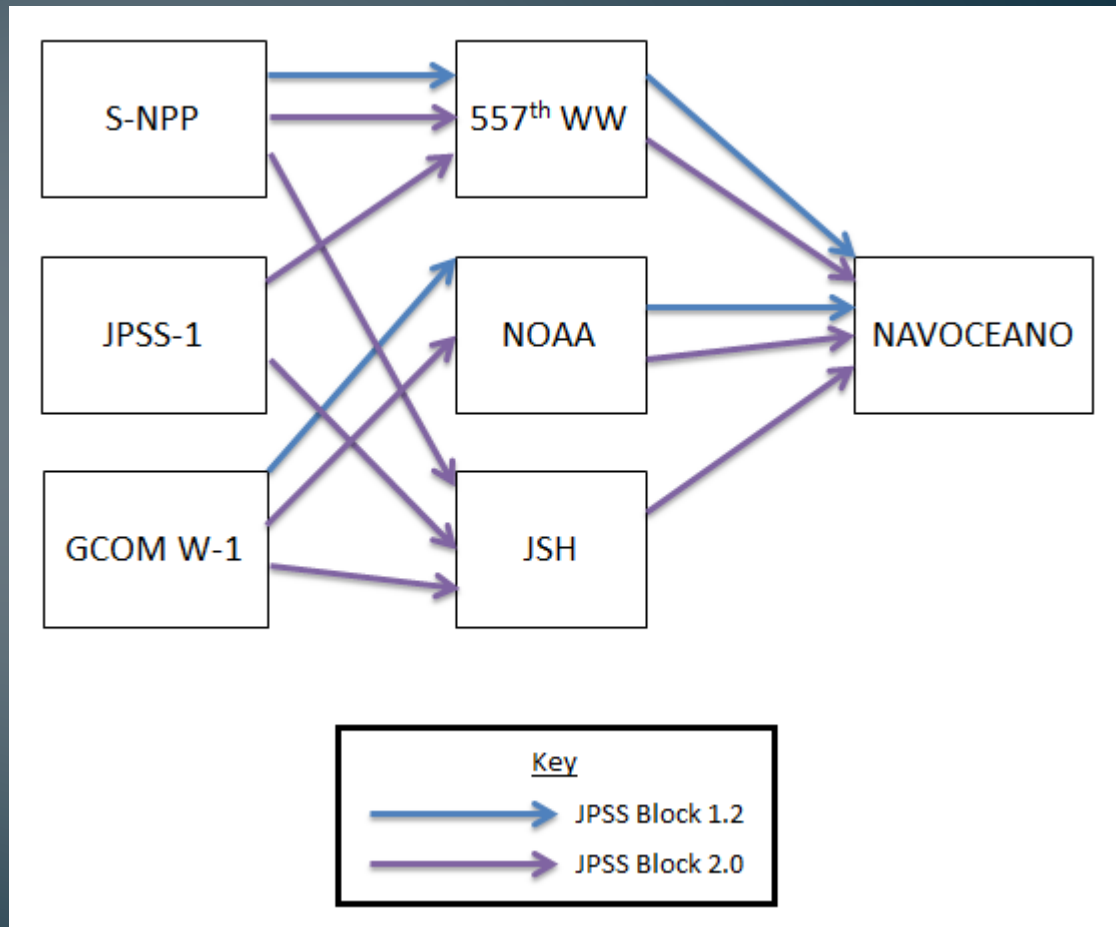

JSH Data Paths

Current

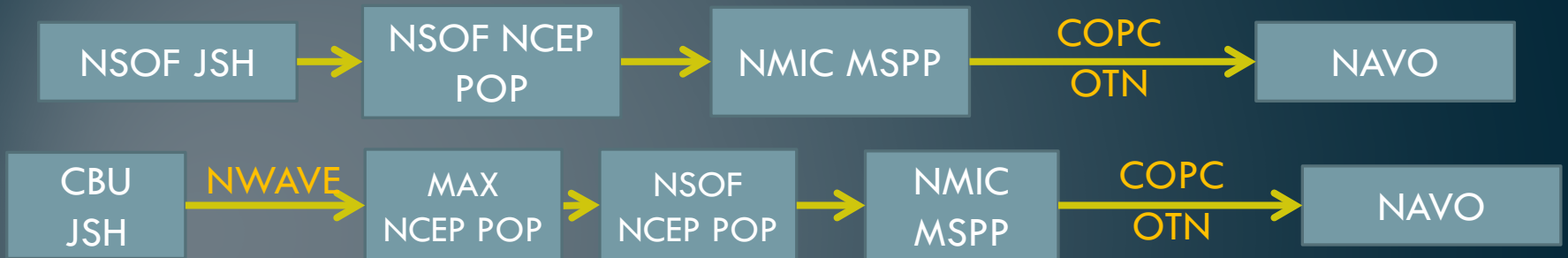

Planned with COPC Assistance

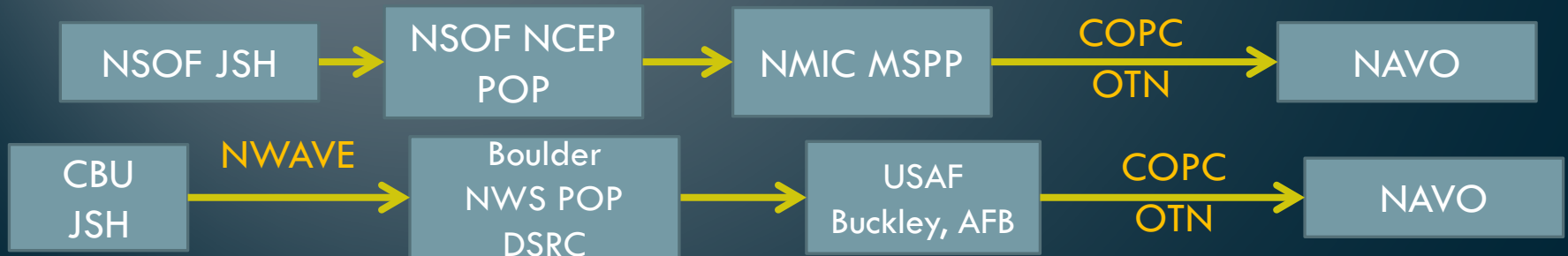

Questions???